

Ordering spares / Ersatzteil - Regelung / Pièces de rechange / Parti di ricambio / Lista de recambios / Onderdelen bestellen (NL/B) / Κωδικοί Ανταλλακτικών / Bestilling af reservedele / Beställning av reservdelar / Bestilling av reservedeler / Резервни части / Запчасти / Części zapasowe / Piese de schimb / Rendelhető alkatrészek / Запасні частини / Резервни делови / Резервни делови / Atsarginių dalių / Tellitavad varuosad / Rezerves daļas / Náhradní díly / Náhradné diely / Yedek parça siparişi / Nadomestni deli

XX = AA, AD, .....

- 1 - B 961716 XX
- 2 - B 960473 XX
- 3 - B 961438 XX
- 4 - B 961374 NU
- 5 - A 861181 NU
- 6 - A 861156 NU
- 7 - E 960059 NU
- 8 - B 960486 XX
- 9 - A 960537 XX
- 10 - B 960167 XX
- 11 - A 960944 NU
- 12 - B 960241 XX
- 13 - B 960604 XX
- 14 - B 9467 XX
- 15 - B 9400 XX
- 16 - A 961640 NU
- 17 - B 964675 XX
- 18 - B 961346 NU

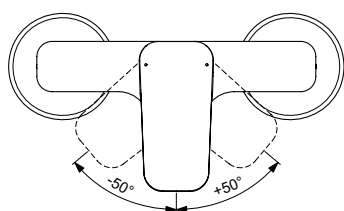
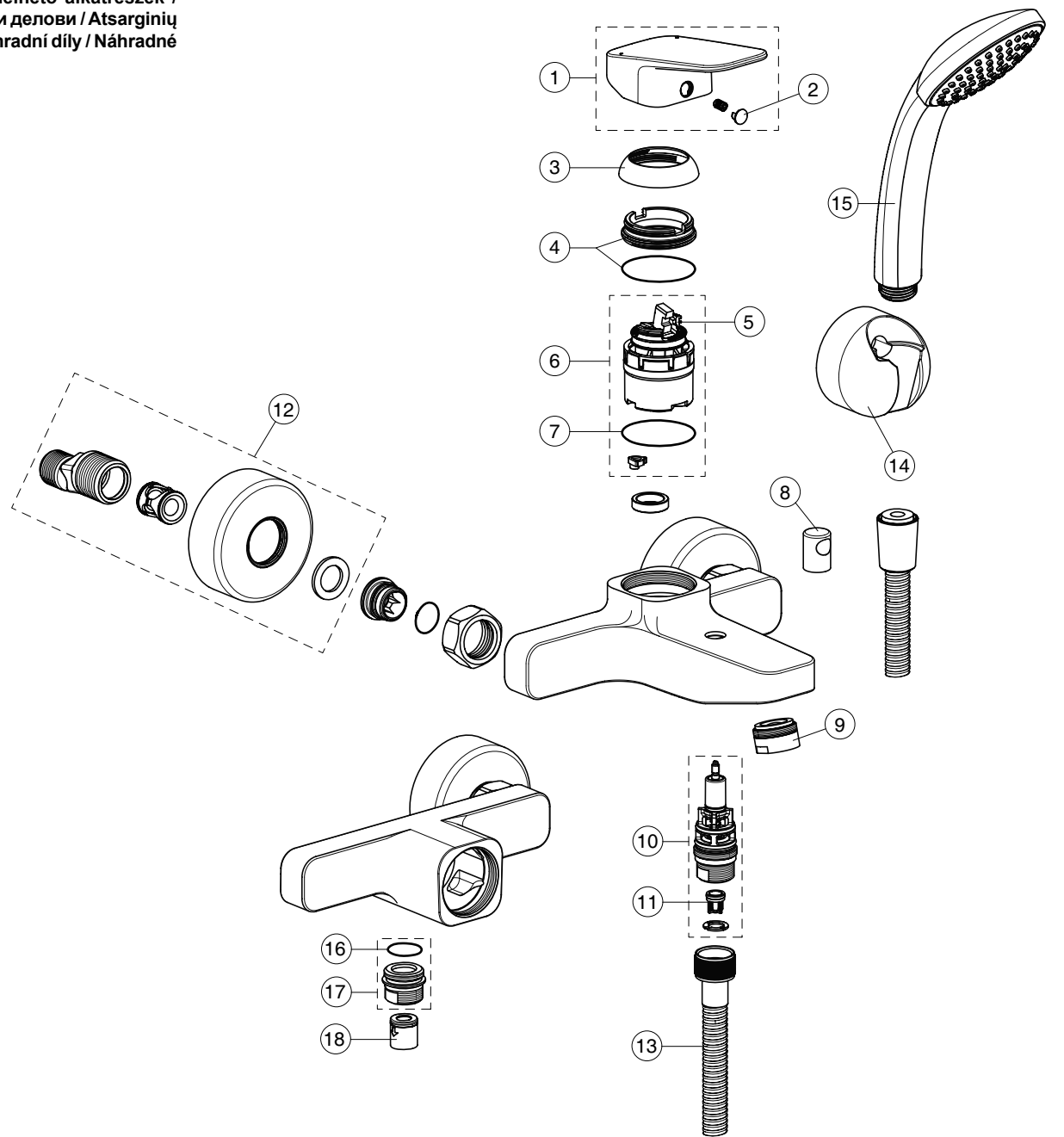

B D251 ..

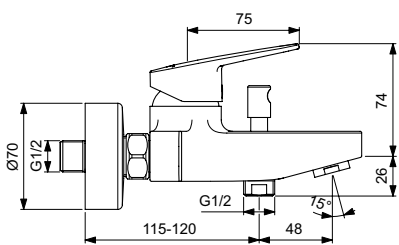
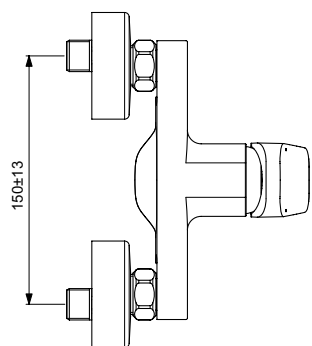
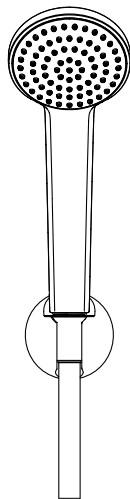
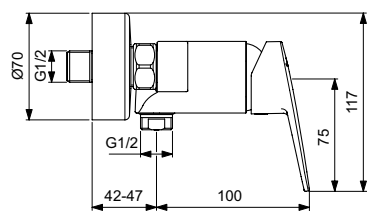

B D258 ..

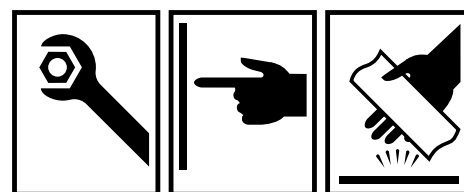
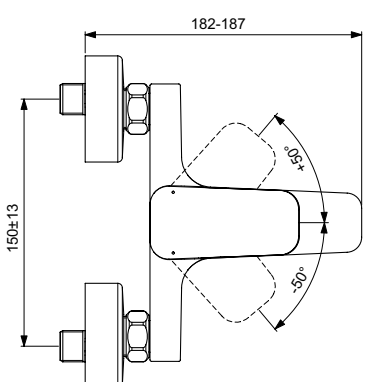

**CERAPLAN**



**Ideal Standard**

10.2021 / B565147

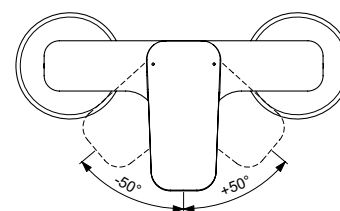

B D250 ..

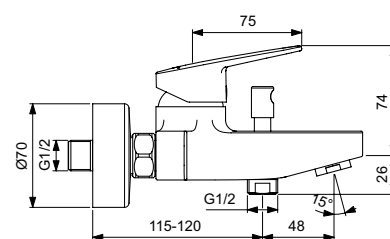
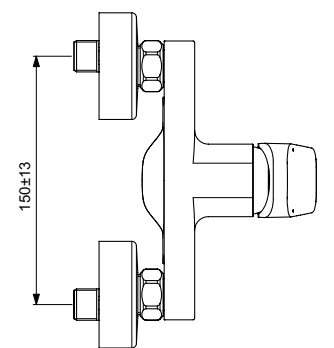
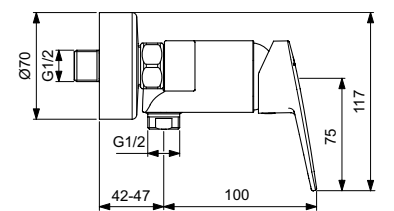

B D256 ..

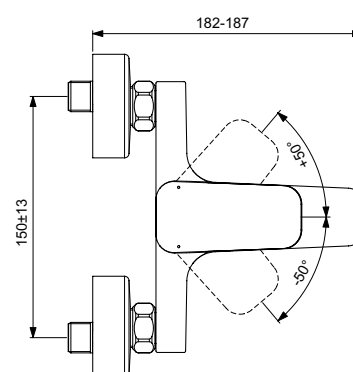

Ideal Standard International NV  
Corporate Village – Gent Building  
Da Vincilaan 2  
1935 Zaventem  
Belgium  
<http://www.idealstandardinternational.com>

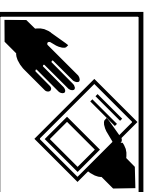

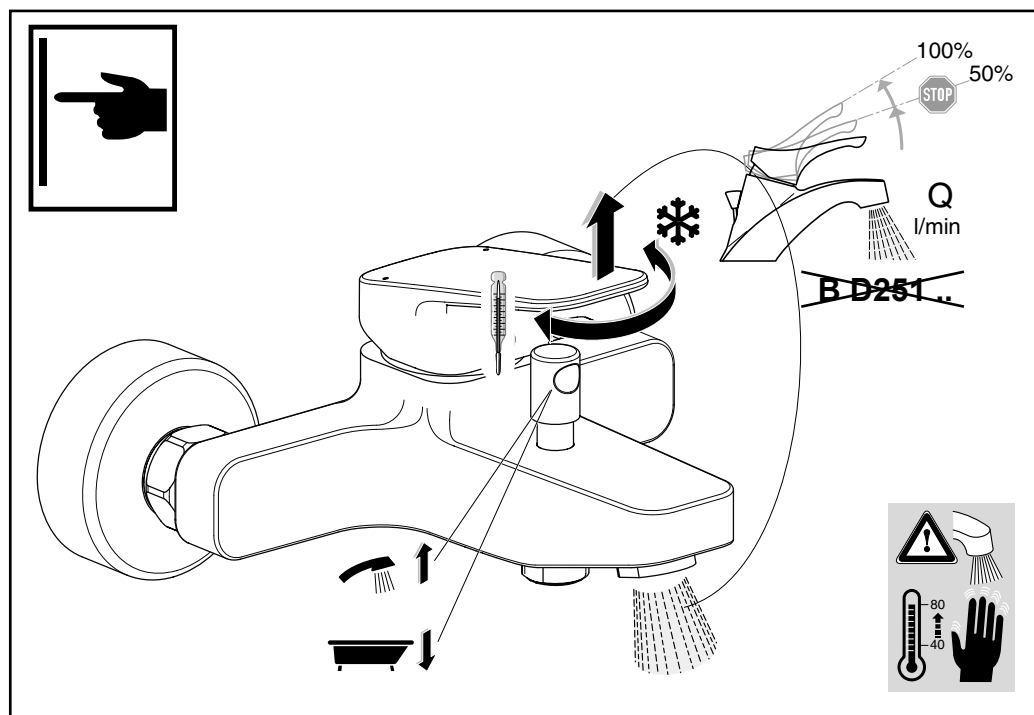
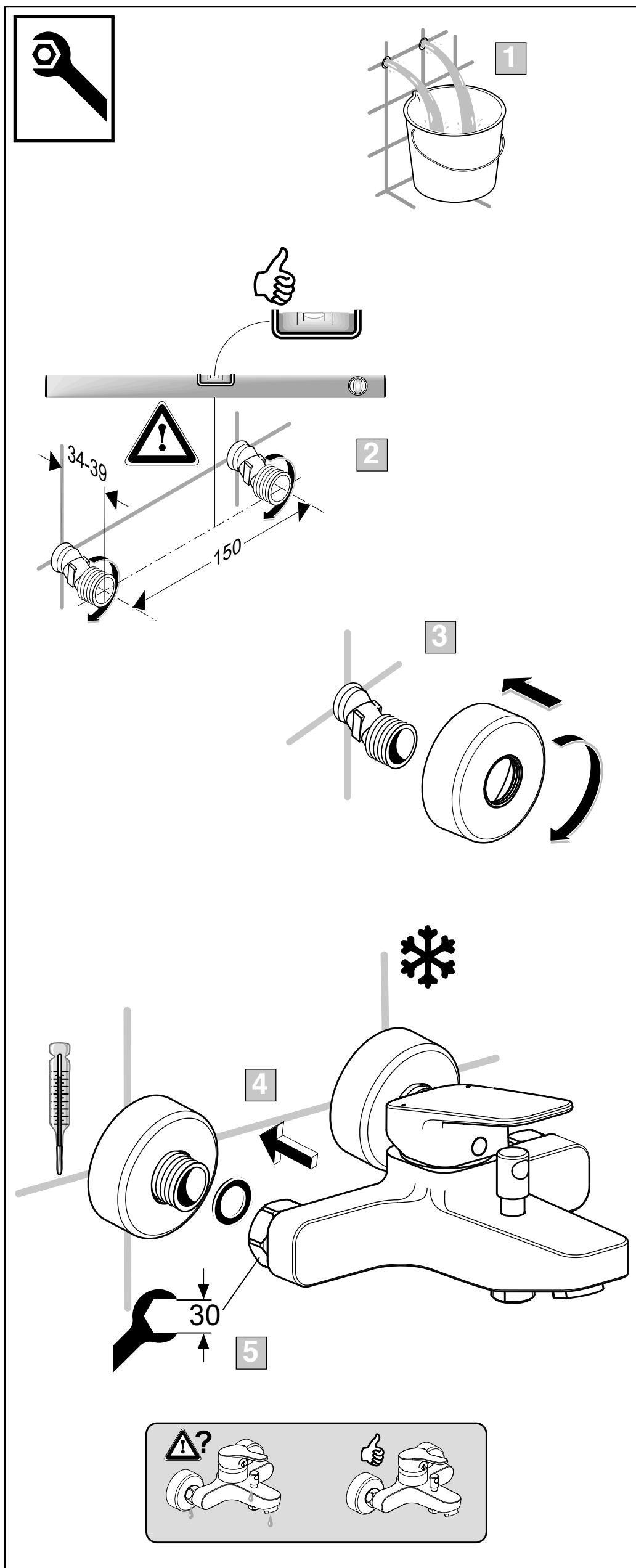

P	T	°C	Q (3 bar)					
			0	1	2	3	4	5
0,3 MPa 3 bar	50°C	15°C	50	49	44	40	35	33
	65°C	15°C	65	63	57	50	44	40
	85°C	15°C	85	83	74	64	56	50

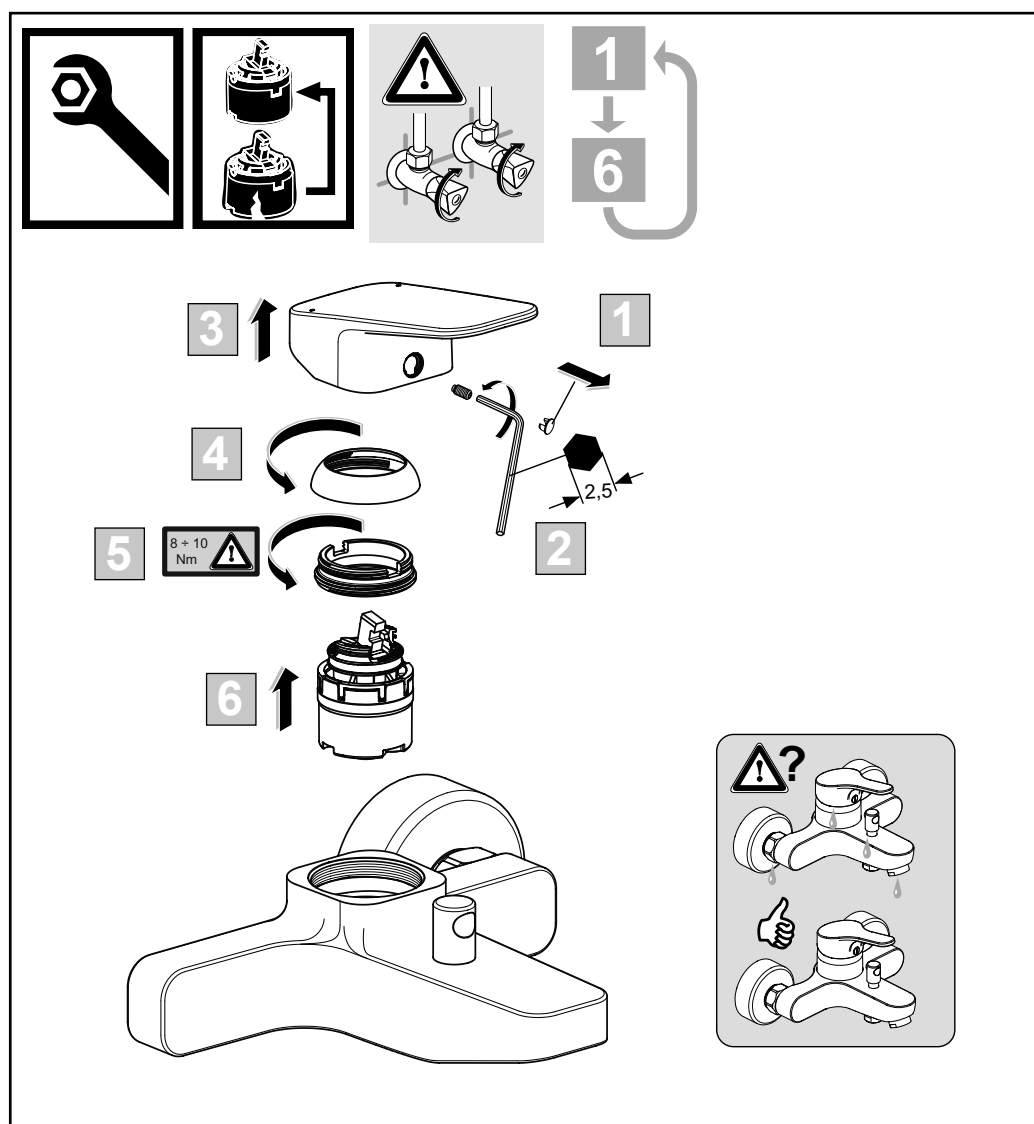

P	bar	MAX. 10	5	Q (3 bar)
0,5				
T	°C	MAX. 80	65	l/min
40				20
				13
BD251..				8