

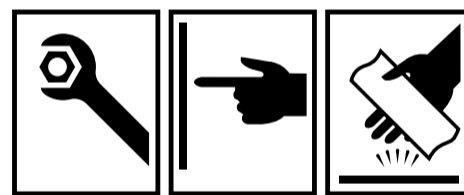

Ordering spares / Ersatzteil - Regelung / Pièces de rechange / Parti di ricambio / Lista de recambios / Onderdelen bestellen (NL/B) / Κωδικοί Ανταλλακτικών / Bestilling af reservedele / Beställning av reservdelar / Bestilling av reservedeler / Резервни части / Запчасти / Części zapasowe / Piese de schimb / Rendelhető alkatrészek / Запасні частини / Резервни делови / Резервни делови / Atsarginių dalių / Tellitavad varuosad / Rezerves daļas / Náhradní díly / Náhradné diely / Yedek parça siparişi / Nadomestni deli

XX = AA, AD,

- 1 - B 961852 XX
- 2 - A 963751 NU
- 3 - B 961373 XX
- 4 - B 961374 NU
- 5 - A 861181 NU
- 6 - A 861156 NU
- 7 - A 960063 XX
- 8 - B 960754 XX
- 9 - A 964520 NU
- 10 - B 960900 XX
- 11 - B 964550 XX
- 11a - A 962991 XX

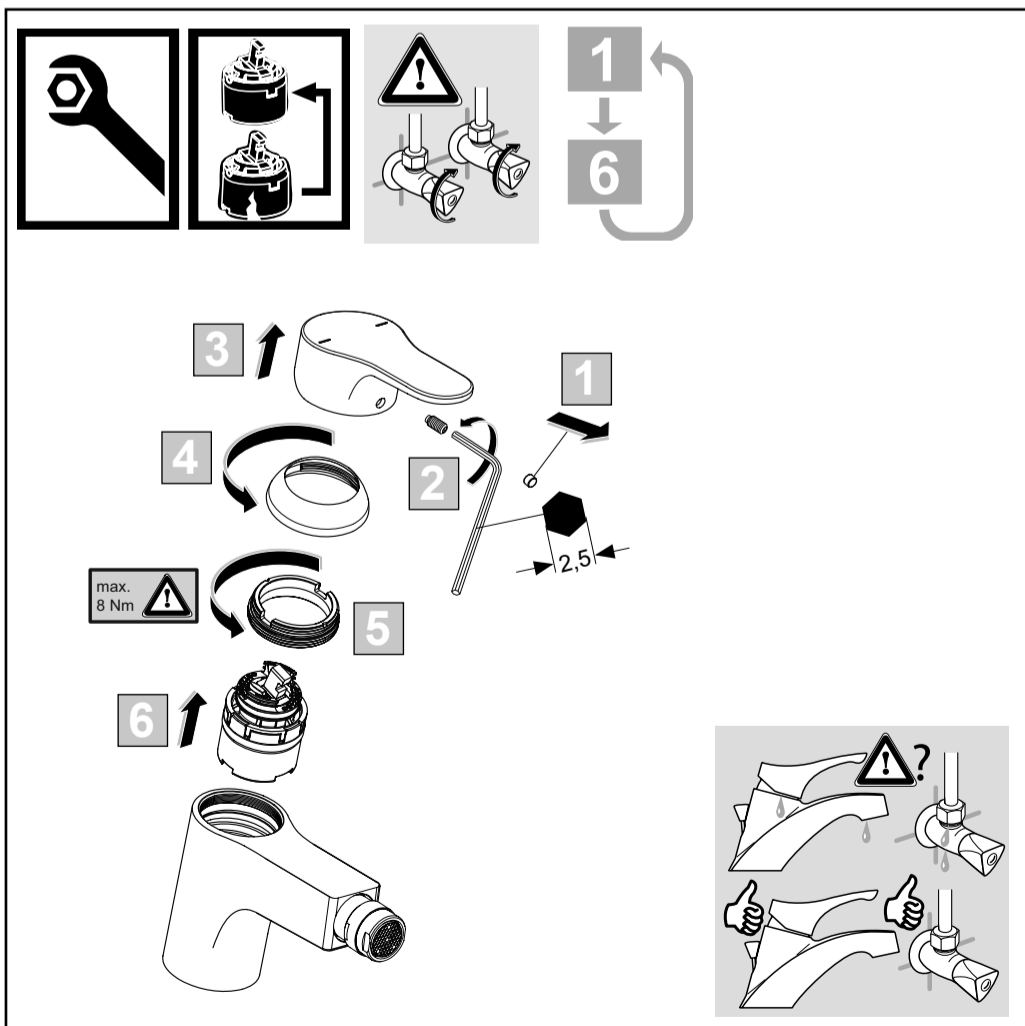
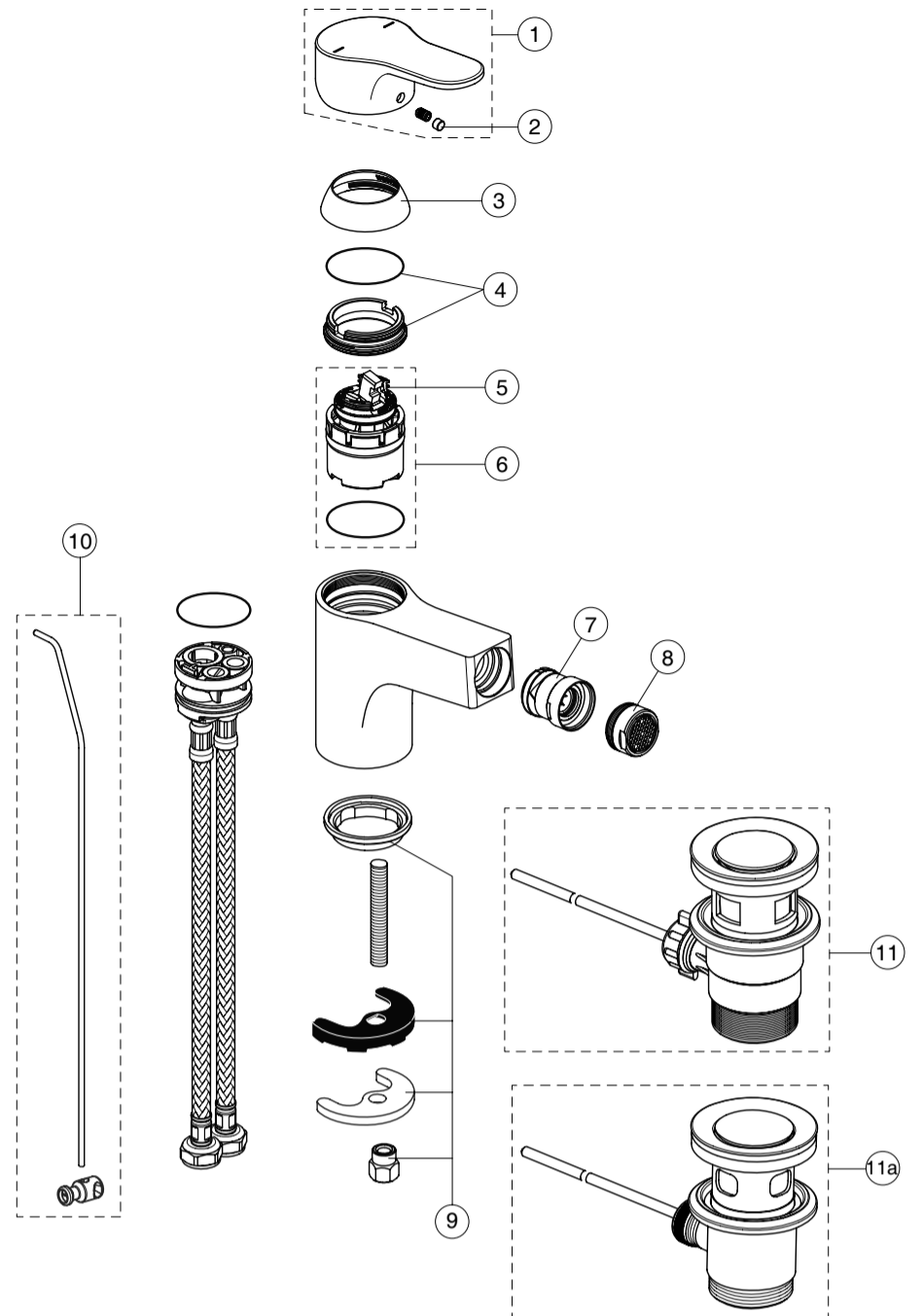

Ideal Standard

CERABASE

08.2022 / B565306

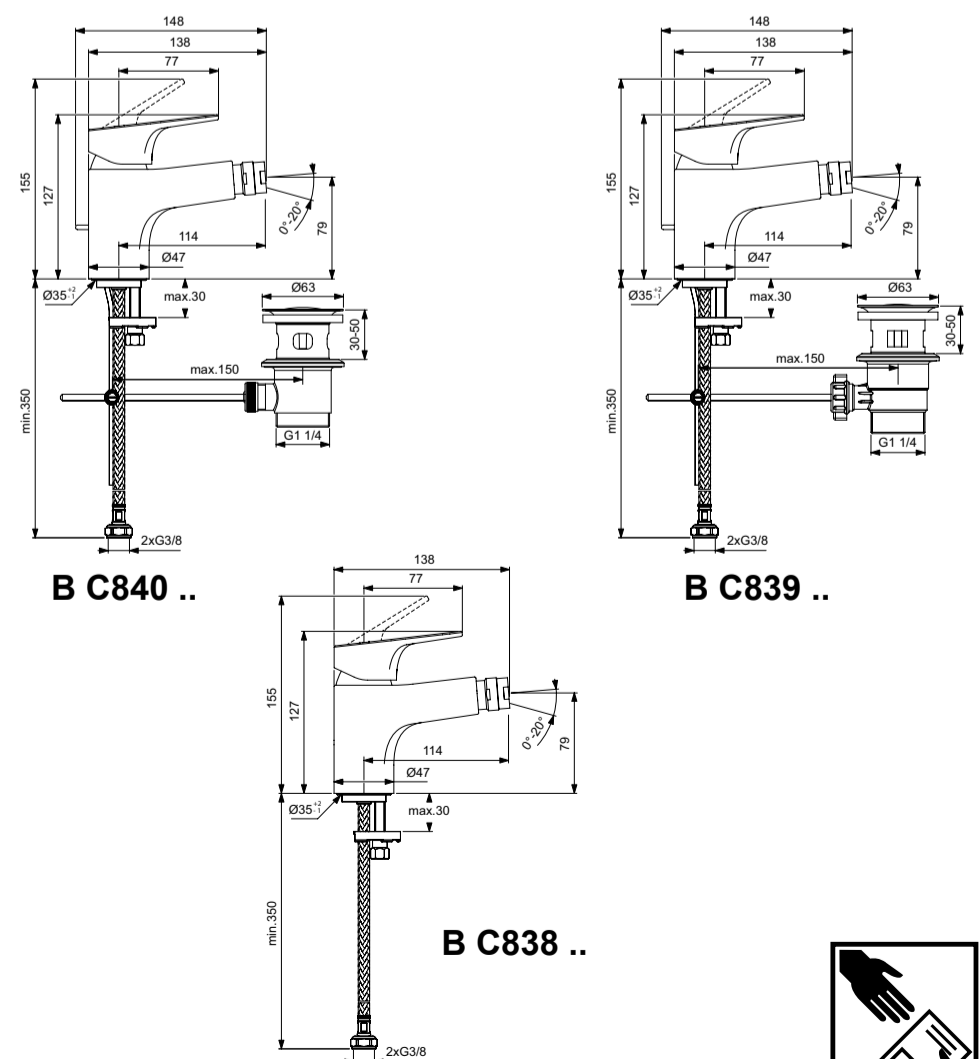

Ideal Standard International NV
Corporate Village – Gent Building
Da Vincilaan 2
1935 Zaventem
Belgium
<http://www.idealstandardinternational.com>

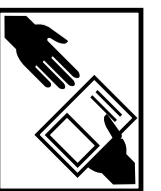

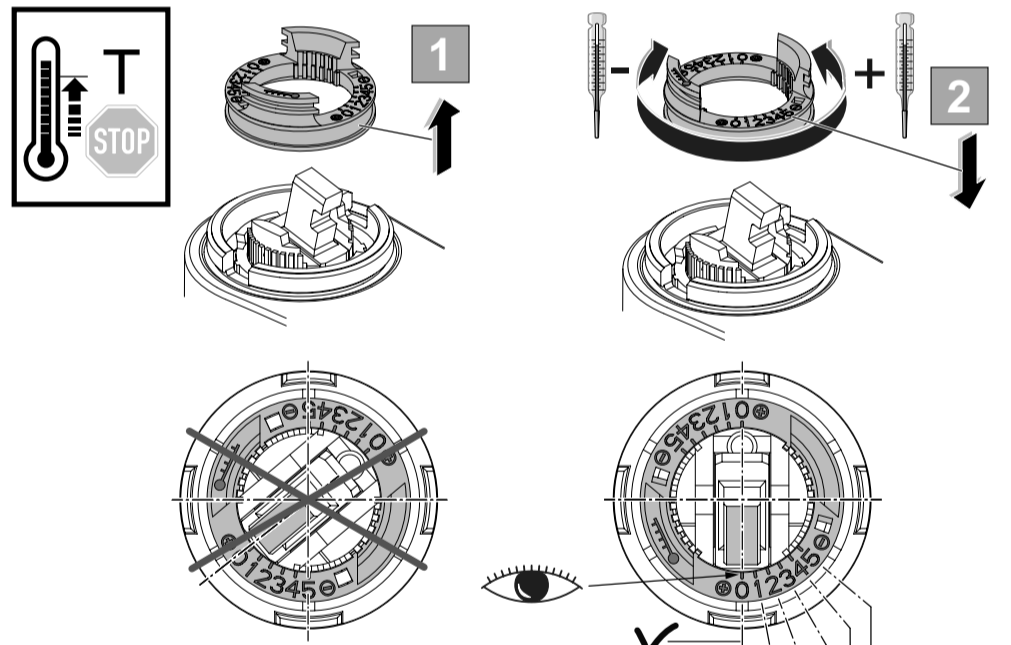
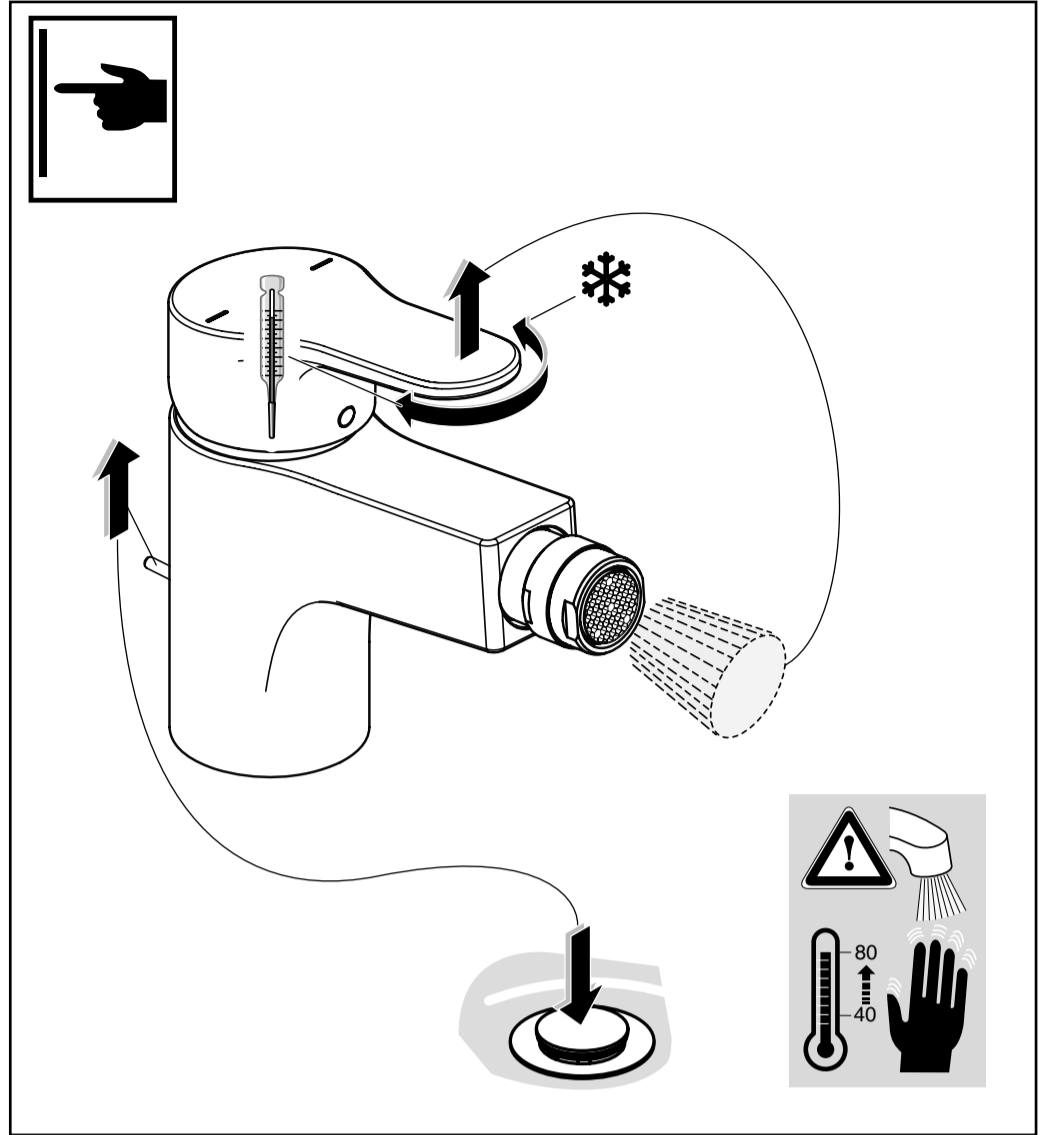
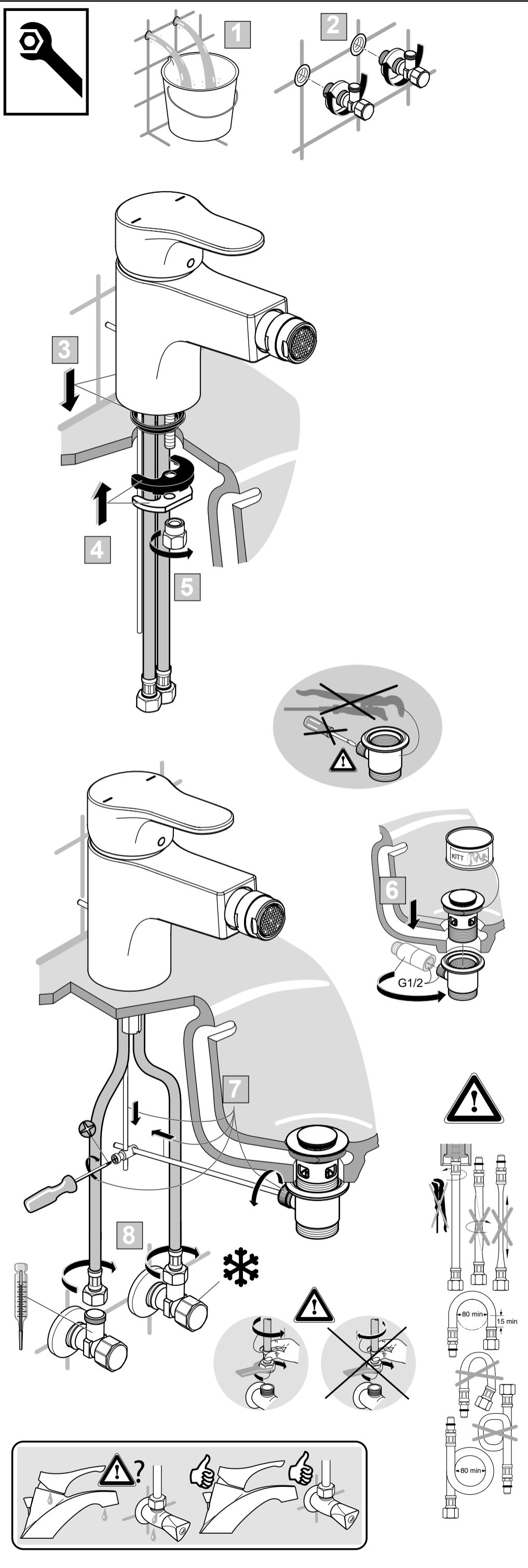

P	T	Snowflake	0	1	2	3	4	5
			°C	°C	°C	°C	°C	°C
0,3 MPa 3 bar	50°C	15°C	50	49	44	40	35	33
	65°C	15°C	65	63	57	50	44	40
	85°C	15°C	85	83	74	64	56	50

P	bar	0,5	MAX. 10	5	Q (3 bar)
T	°C	MAX. 80	65	40	l/min
					5